

Sequence Analysis



ECS129
PATRICE KOEHL

Sequence Analysis: Outline

1. Why do we compare sequences?
2. Sequence comparison: from qualitative to quantitative methods
3. Deterministic methods: Dynamic programming
4. Heuristic methods: BLAST
5. Multiple Sequence Alignment

Sequence Analysis: Outline

1. Why do we compare sequences?
 1. Biological sequences
 2. Homology vs analogy
 3. Homology: orthology and paralogy
 4. Applications
2. Sequence comparison: from qualitative to quantitative methods
3. Deterministic methods: Dynamic programming
4. Heuristic methods: BLAST
5. Multiple Sequence Alignment

Similarity: Homology vs Analogy

Homology: Similarity in characteristics resulting from shared ancestry.

Analogy: The similarity of characteristics between two species that are not closely related; attributable to convergent evolution.

Similar due to inheritance



Two sisters: homologs

*Similar due to...
uh...other factors*



Two "Elvis": analogs

Homology: Orthologs and Paralogs

Homology:

Similarity in characteristics resulting from shared ancestry.

Paralogy:

Homologous sequences are paralogous if they were separated by a gene duplication event

Orthology:

Homologous sequences are orthologous if they were separated by a speciation event

Further reading:

*Koonin EV (2005). "Orthologs, paralogs, and evolutionary genomics".
Annu. Rev. Genet. 39:309-338.*

Homology: Orthologs and Paralogs

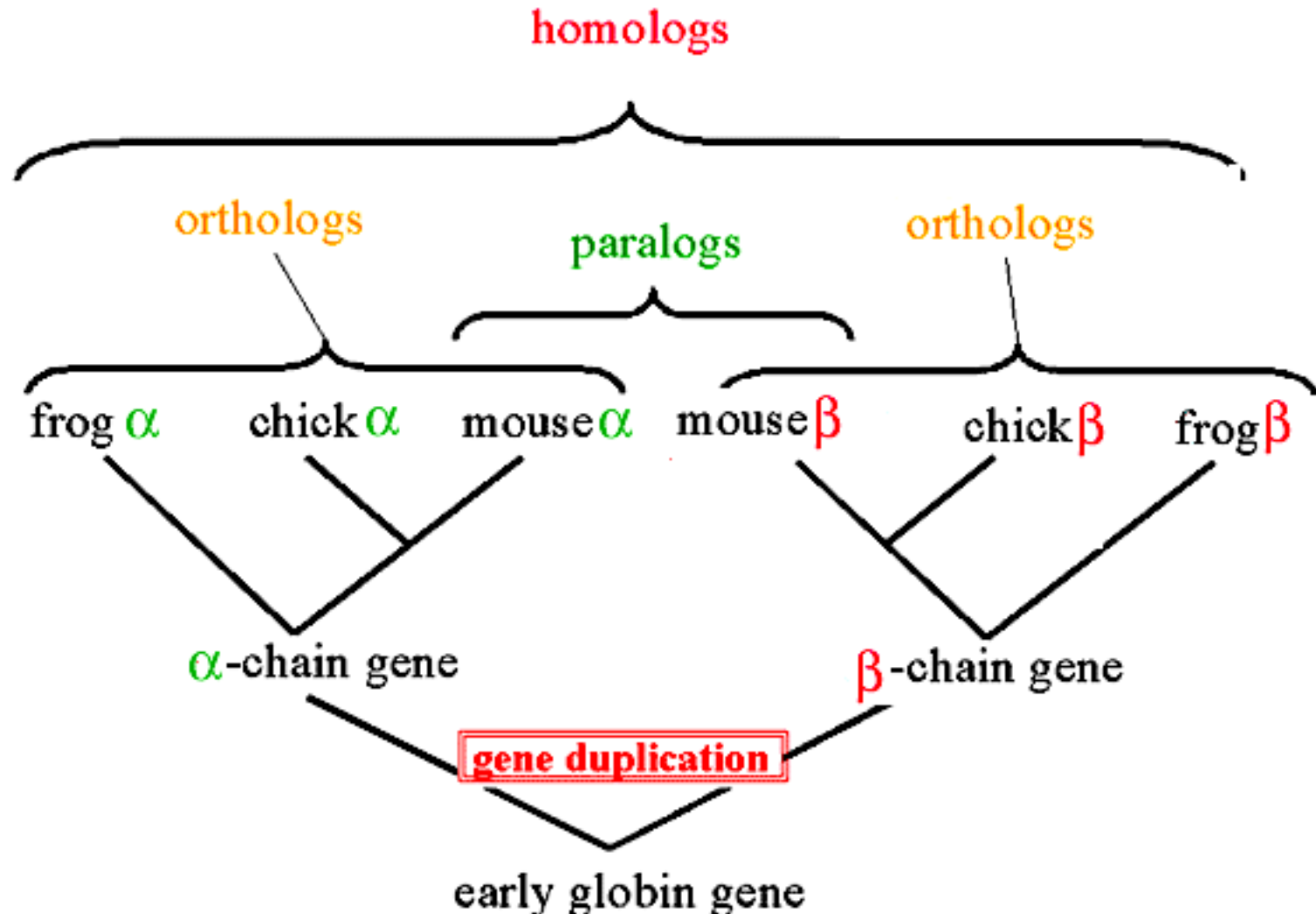

Applications of Sequence Analysis

- Sequencing projects, assembly of sequence data
- Evolutionary history
- Identification of functional elements in sequences
- gene prediction
- Classification of proteins
- Comparative genomics
- RNA structure prediction
- Protein structure prediction
- Health Informatics

Sequence Analysis: Outline

1. Why do we compare sequences?
2. Sequence comparison: from qualitative to quantitative methods
 1. Sequence composition
 2. Sequence comparison: DotPlot
 3. Sequence alignment
3. Deterministic methods: Dynamic programming
4. Heuristic methods: BLAST
5. Multiple Sequence Alignment

DNA sequence: Chargaff's rules

Rule 1: In double stranded DNA, the amount of guanine is equal to cytosine and the amount of adenine is equal to thymine

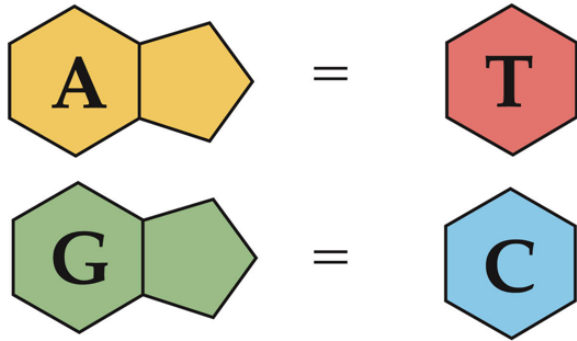

(basis of Watson Crick base pairing)

Rule 2: the composition of DNA varies from one species to another; in particular in the relative amounts of A, G, T, and C bases

DNA sequence: Chargaff's rules

Table 3-2 Data Leading to the Formulation of Chargaff's Rules

Source	Adenine to Guanine	Thymine to Cytosine	Adenine to Thymine	Guanine to Cytosine	Purines to Pyrimidines
Ox	1.29	1.43	1.04	1.00	1.1
Human	1.56	1.75	1.00	1.00	1.0
Hen	1.45	1.29	1.06	0.91	0.99
Salmon	1.43	1.43	1.02	1.02	1.02
Wheat	1.22	1.18	1.00	0.97	0.99
Yeast	1.67	1.92	1.03	1.20	1.0
<i>Hemophilus influenzae</i>	1.74	1.54	1.07	0.91	1.0
<i>E-coli</i> K2	1.05	0.95	1.09	0.99	1.0
Avian tubercle bacillus	0.4	0.4	1.09	1.08	1.1
<i>Serratia marcescens</i>	0.7	0.7	0.95	0.86	0.9
<i>Bacillus schatz</i>	0.7	0.6	1.12	0.89	1.0

SOURCE: After E. Chargaff et al., *J. Biol. Chem.* 177 (1949).

Comparing sequences based on their tri-peptide content

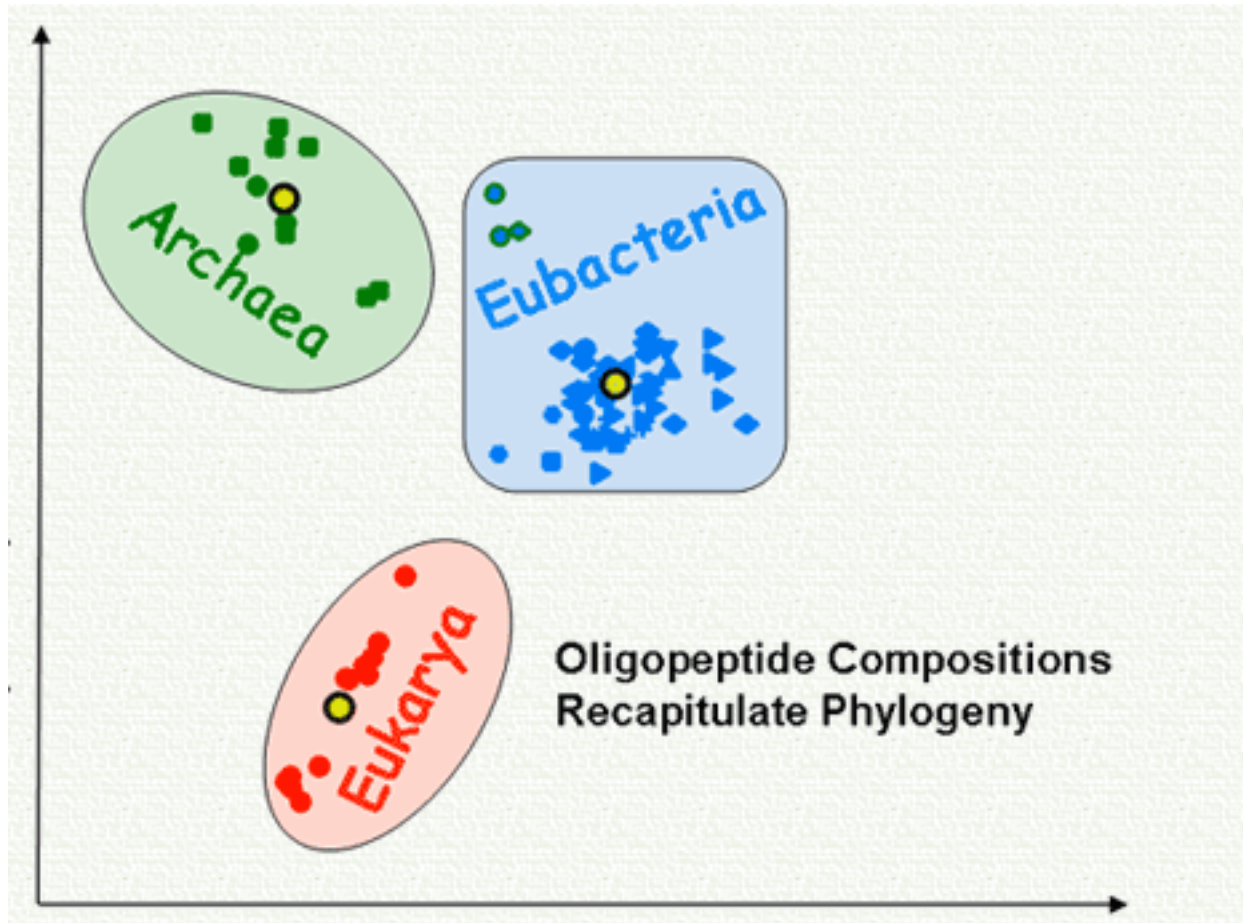

Proteins: Structure, Function and Genetics **54**, 20-40 (2004)

Comparing individual letters

Scores are usually stored in a “weight” matrix also called “substitution” matrix or “matching” matrix.

Defining the “proper” matrix is still an active area of research:

1. Identity matrix

2. Chemical property matrix

In this matrix amino acids or nucleotides are intuitively classified on the basis of their chemical properties

3. Substitution-based matrix

Dayhoff matrix

PAM matrices

Blosum matrices

Substitution Matrices

Dayhoff matrix was created in 1978 based on few closely related (> 85% identity) sequences available this time (1500 aligned amino-acids).

PAM-family of matrices is a simple update of the original Dayhoff matrix.

Gonnet matrices were created by exhaustive alignment of all Database sequences in 1992.

BLOSUM matrix is based on local similarities (blocks) of proteins rather than overall alignments.

Most common Scoring Matrices

BLOSUM matrices (*Henikoff and Henikoff, 1992*)

- Start from “reliable” alignments of sequences with at least **XX** % identity
- Compute mutation probabilities
- Convert into Scores: -> BLOSUM**XX** matrix

PAM matrices (*Dayhoff, 1974*)

- Point Accepted Mutation
- Start with PAM score = 1: alignments of sequences with 1 mutation -> PAM1 matrix
- Generate successive PAM matrices:
 $\text{PAM}_{\text{XX}} = (\text{PAM1})^{\text{XX}}$

Example of a Scoring matrix: Blosom62

	C	S	T	P	A	G	N	D	E	Q	H	R	K	M	I	L	V	F	Y	W
C	9	-1	-1	-3	0	-3	-3	-3	-4	-3	-3	-3	-3	-1	-1	-1	-1	-2	-2	-2
S	-1	4	1	-1	1	0	1	0	0	0	-1	-1	0	-1	-2	-2	-2	-2	-2	-3
T	-1	1	4	1	-1	1	0	1	0	0	0	-1	0	-1	-2	-2	-2	-2	-2	-3
P	-3	-1	1	7	-1	-2	-1	-1	-1	-1	-2	-2	-1	-2	-3	-3	-2	-4	-3	-4
A	0	1	-1	-1	4	0	-1	-2	-1	-1	-2	-1	-1	-1	-1	-1	-2	-2	-2	-3
G	-3	0	1	-2	0	6	-2	-1	-2	-2	-2	-2	-2	-3	-4	-4	0	-3	-3	-2
N	-3	1	0	-2	-2	0	6	1	0	0	-1	0	0	-2	-3	-3	-3	-3	-2	-4
D	-3	0	1	-1	-2	-1	1	6	2	0	-1	-2	-1	-3	-3	-4	-3	-3	-3	-4
E	-4	0	0	-1	-1	-2	0	2	5	2	0	0	1	-2	-3	-3	-3	-3	-2	-3
Q	-3	0	0	-1	-1	-2	0	0	2	5	0	1	1	0	-3	-2	-2	-3	-1	-2
H	-3	-1	0	-2	-2	-2	1	1	0	0	8	0	-1	-2	-3	-3	-2	-1	2	-2
R	-3	-1	-1	-2	-1	-2	0	-2	0	1	0	5	2	-1	-3	-2	-3	-3	-2	-3
K	-3	0	0	-1	-1	-2	0	-1	1	1	-1	2	5	-1	-3	-2	-3	-3	-2	-3
M	-1	-1	-1	-2	-1	-3	-2	-3	-2	0	-2	-1	-1	5	1	2	-2	0	-1	-1
I	-1	-2	-2	-3	-1	-4	-3	-3	-3	-3	-3	-3	-3	1	4	2	1	0	-1	-3
L	-1	-2	-2	-3	-1	-4	-3	-4	-3	-2	-3	-2	-2	2	2	4	3	0	-1	-2
V	-1	-2	-2	-2	0	-3	-3	-3	-2	-2	-3	-3	-2	1	3	1	4	-1	-1	-3
F	-2	-2	-2	-4	-2	-3	-3	-3	-3	-3	-1	-3	-3	0	0	0	-1	6	3	1
Y	-2	-2	-2	-3	-2	-3	-2	-3	-2	-1	2	-2	-2	-1	-1	-1	-1	3	7	2
W	-2	-3	-3	-4	-3	-2	-4	-4	-3	-2	-2	-3	-3	-1	-3	-2	-3	1	2	11

BLOSUM30: 2D Projection

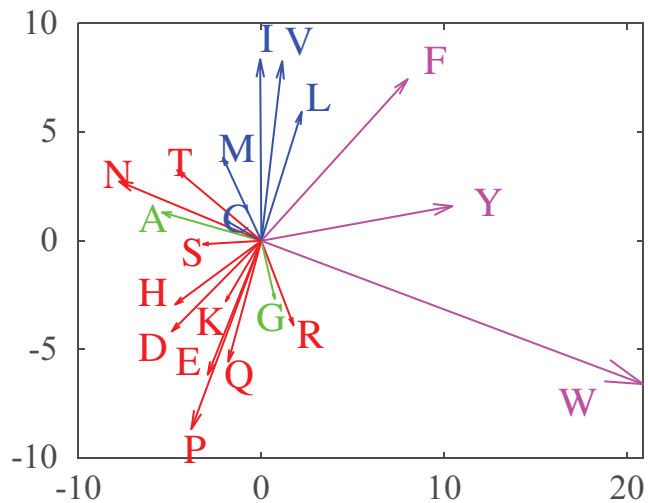

BLOSUM30: 3D Projection

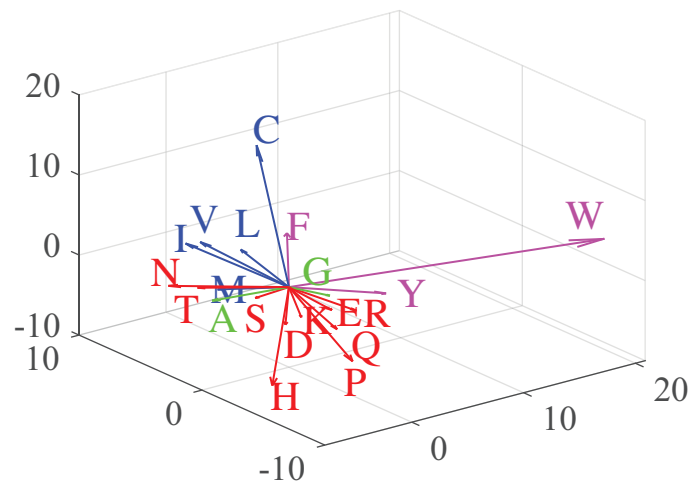

BLOSUM62: 2D Projection

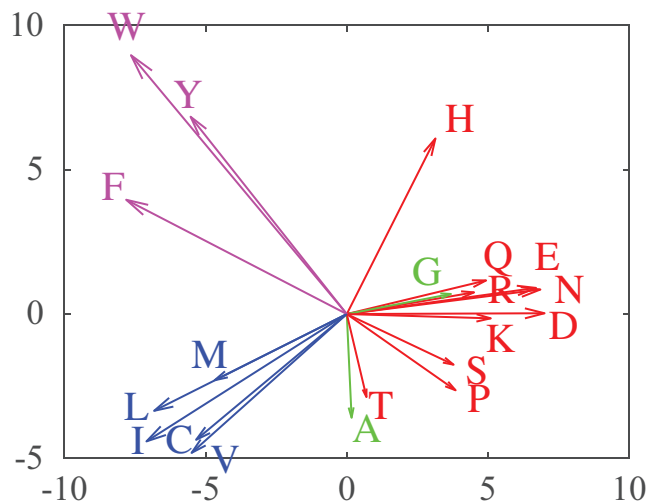

BLOSUM62: 3D Projection

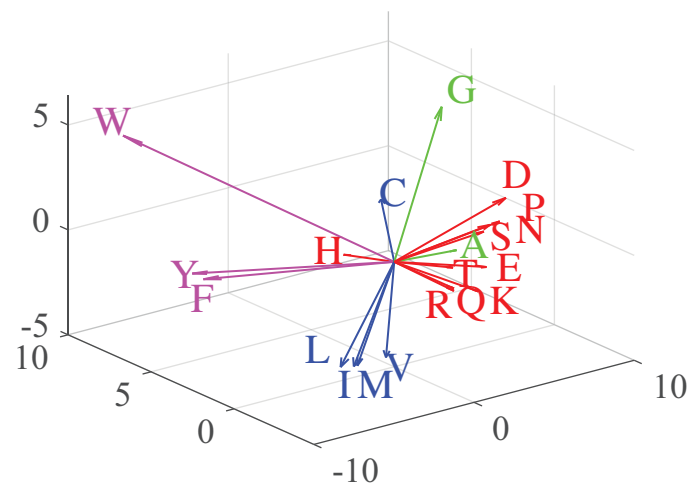

DotPlot: Overview of Sequence Similarity

Build a table S :

- rows: Sequence 1
- columns: Sequence 2

Assign a score $S(i,j)$ to each entry in the table:

- select a window size WS

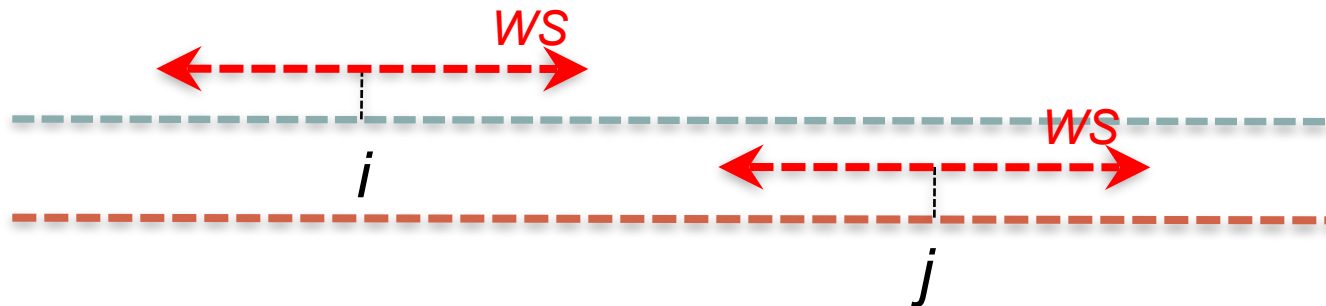

- Compare window around i with window around j \rightarrow $Score(i,j)$

Display table of scores S

- show a dot at position (i,j) if $Score(i,j) > Threshold$

Patterns on DotPlot



Internal Repeat

Insertion (Deletion)

Divergence

Patterns on DotPlot

Sequence 2

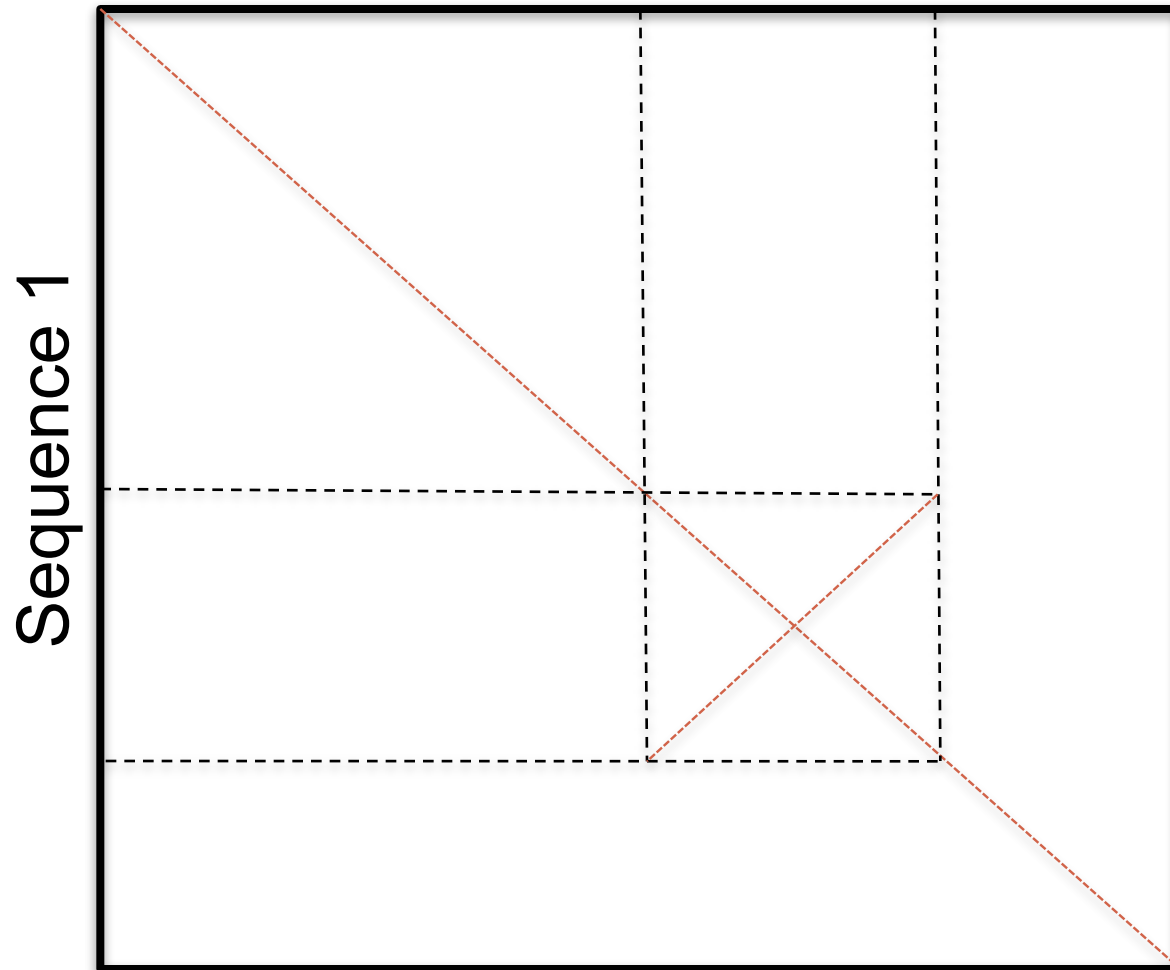

Patterns on DotPlot

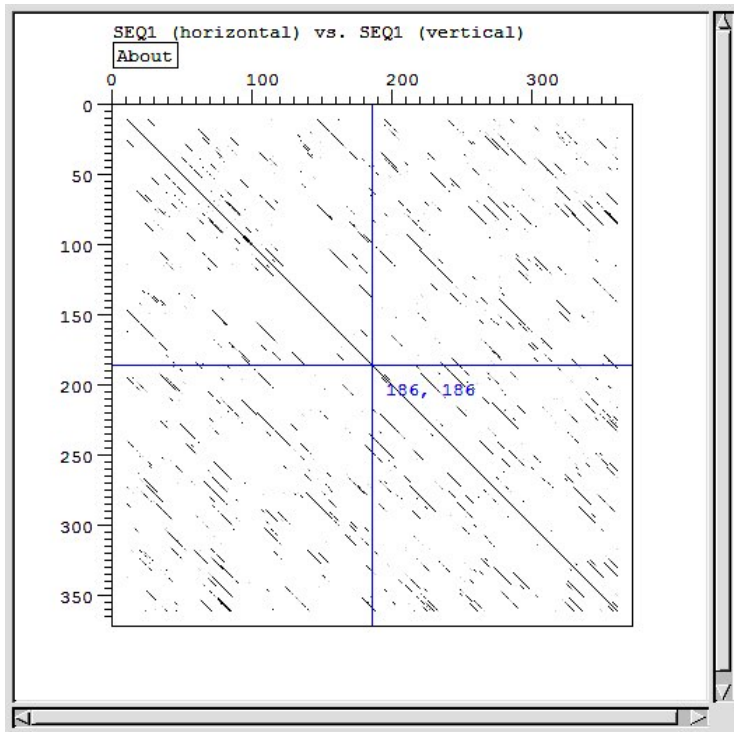

With many details

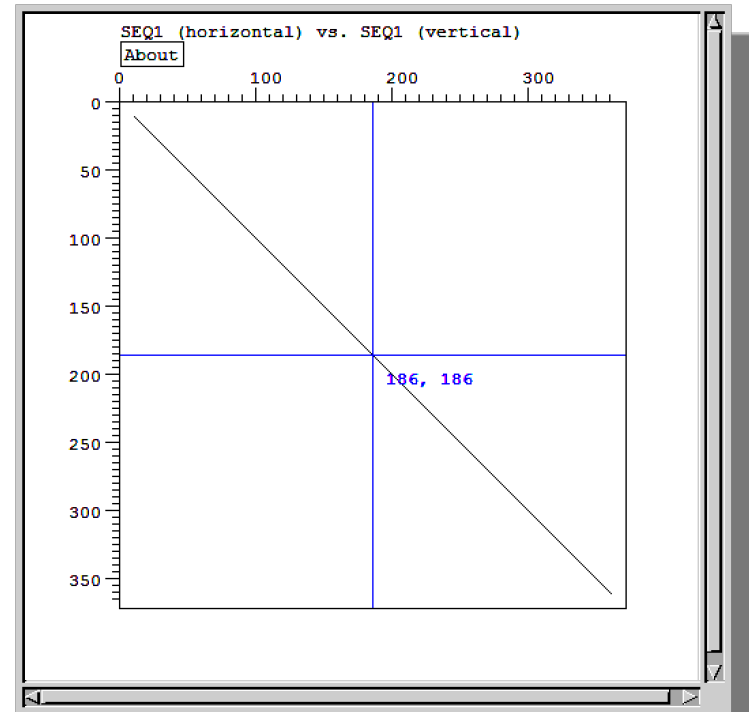

Overall view - no details

What is sequence alignment?

Given two sequences of letters and a **scoring scheme** for evaluating letter matching, find the optimal pairing of letters from one sequence to the other.

Human hemoglobin (α chain)

VLSPADKTNVKAAWGKVGAHAGEYGAEALERMF LSFPTTKTYFPHFDLSHG
SAQVKGHGKKVADAL TNAVAHVDDMPNAL SALSDLHAHKLRVDPVNFKLLS
HCLLVTLAAHLPAEFTPAVHASLDKFLASVSTVLT SKYR

Human myoglobin

GLSDGEWQLVLNWWGKVEAD I PGHGQEV L I RL FKGHPET LEKFDKFKHLKS
EDEMKASEDLKKHGATVLTALGG I LKKKGHHEAE I KPLAQSHATKHK I PVK
YLEF I SECI IQVLQSKHPGDFGADAQGAMNKALELFRKDMASNYKELGFQG

Ungapped Alignment



(B)

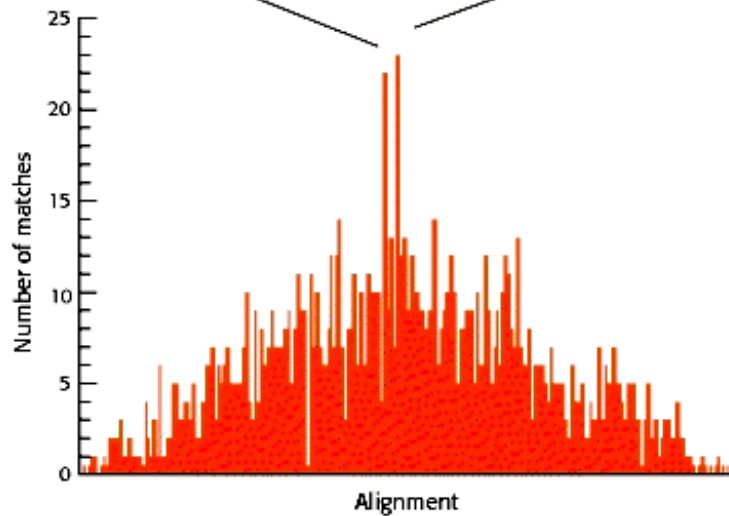
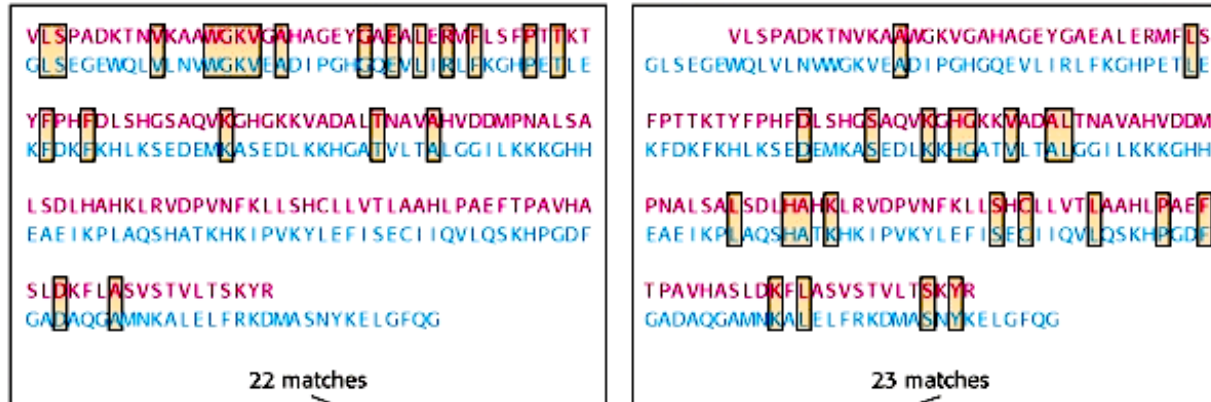

(From Biochemistry,
Stryer, fifth edition)

Alignment with gap(s)



How do we generate the “best” gapped alignment ?

Total number of possible gapped alignment: $\sum_{k=1}^{\min(N, M)} \binom{N}{k} \binom{M}{k}$

Sequence Analysis: Outline

1. Why do we compare sequences?
2. Sequence comparison: from qualitative to quantitative methods
3. Deterministic methods: Dynamic programming
 1. Concept
 2. Global Alignment
 3. Statistics
 4. Local Alignment
4. Heuristic methods: BLAST
5. Multiple Sequence Alignment

DP and Sequence Alignment

Key idea:

The score of the optimal alignment that ends at a given pair of positions in the sequences is the score of the best alignment previous to these positions plus the score of aligning these two positions.

DP and Sequence Alignment

Test all alignments that can lead to i aligned with j

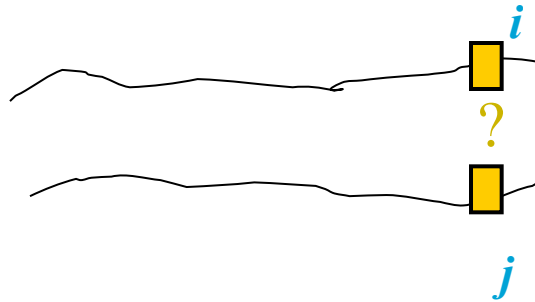

DP and Sequence Alignment

Test all alignments that can lead to i aligned with j

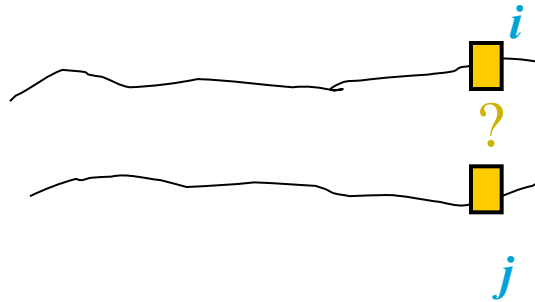

3 possibilities:

1) $i-1$ aligned with $j-1$

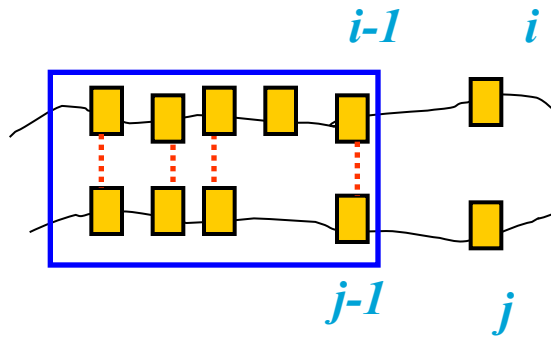

DP and Sequence Alignment

Test all alignments that can lead to i aligned with j

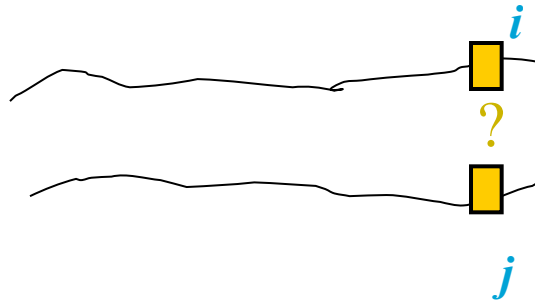

3 possibilities:

- 1) $i-1$ aligned with $j-1$
- 2) $i-1$ aligned with k
 $1 \leq k \leq j-2$

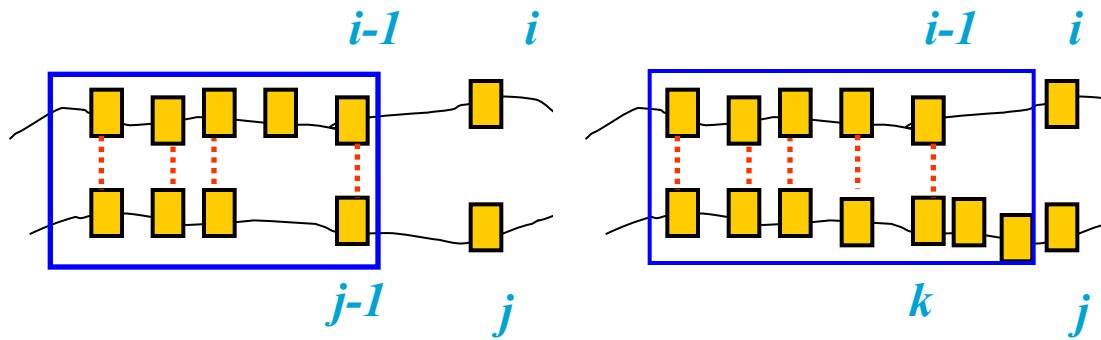

-> Choose alignment yielding best score

DP and Sequence Alignment

Test all alignments that can lead to i aligned with j

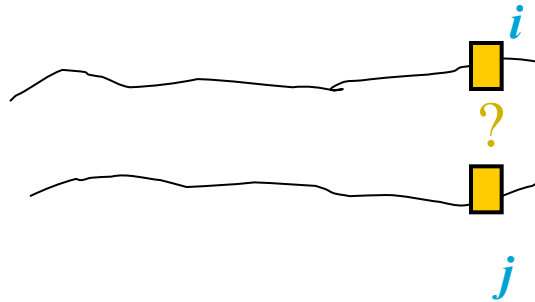

3 possibilities:

1) $i-1$ aligned with $j-1$

2) $i-1$ aligned with k
 $1 \leq k \leq j-2$

3) $j-1$ aligned with l ,
 $1 \leq l \leq i-2$

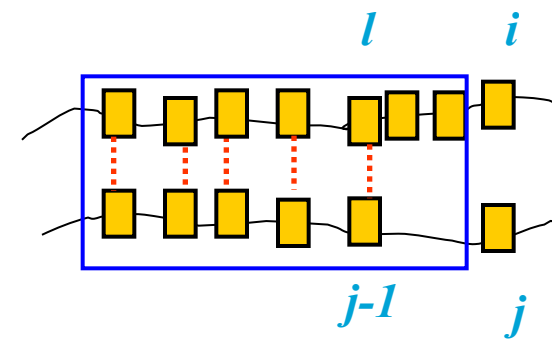
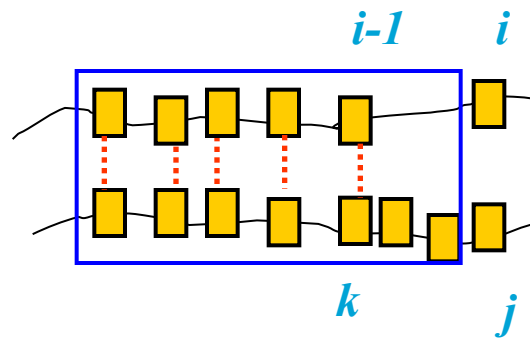
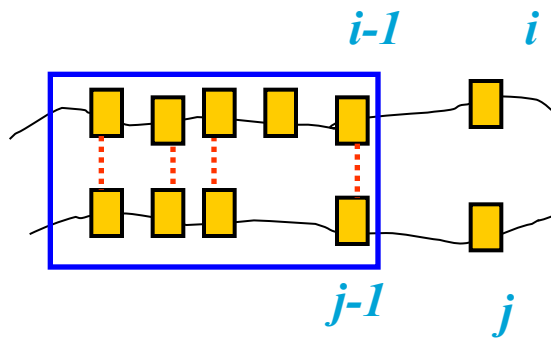

-> Choose alignment yielding best score

Implementing the DP algorithm for sequences

Aligning 2 sequence $S1$ and $S2$ of lengths N and M :

- 1) Build a $N \times M$ alignment matrix A such that $A(i,j)$ is the optimal score for alignments up to the pair (i,j)
- 2) Find the best score in A
- 3) Track back through the matrix to get the optimal alignment of $S1$ and $S2$.

Example

Sequence 1: AWVCDEC

Sequence 2: AWEC

Score(i,j) = 10 if $i=j$, 0 otherwise

no gap penalty

Example

1) Initialize

	A	W	V	C	D	E	C
A	10	0	0	0	0	0	0
W	0						
E	0						
C	0						

Example

2) Propagate

	A	W	V	C	D	E	C
A	10	0	0	0	0	0	0
W	0	20					
E	0						
C	0						



Example

2) Propagate

	A	W	V	C	D	E	C
A	10	0	0	0	0	0	0
W	0	20	10				
E	0						
C	0						



Example

2) Propagate

	A	W	V	C	D	E	C
A	10	0	0	0	0	0	0
W	0	20	10	10	10	10	10
E	0	10	20	20	20	30	20
C	0	10	20	30	20		

Example

3) Trace back

	A	W	V	C	D	E	C
A	10	0	0	0	0	0	0
W	0	20	10	10	10	10	10
E	0	10	20	20	20	30	20
C	0	10	20	30	20	20	40

Alignment:

AWVCDEC

AW-----EC

Total score: 40

Example 2

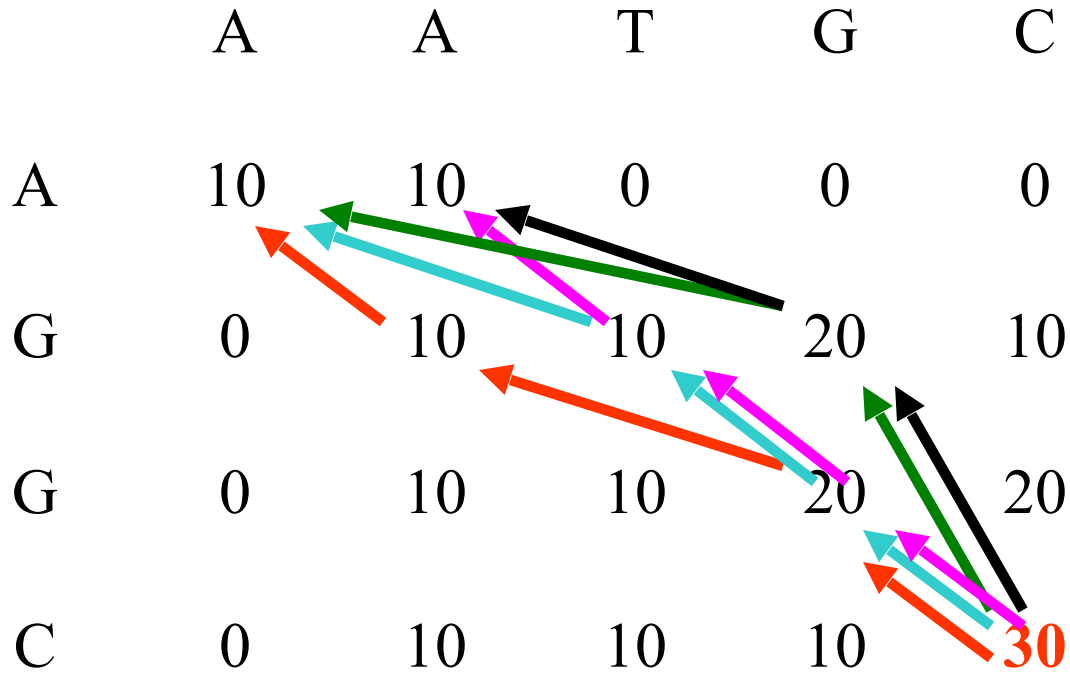

High Score: 30

Alignments:

AATGC
AG GC

AATGC
A GGC

AATGC
AGGC

AATG C
A GGC

AATG C
A GGC

Example 3

Gap cost: -2

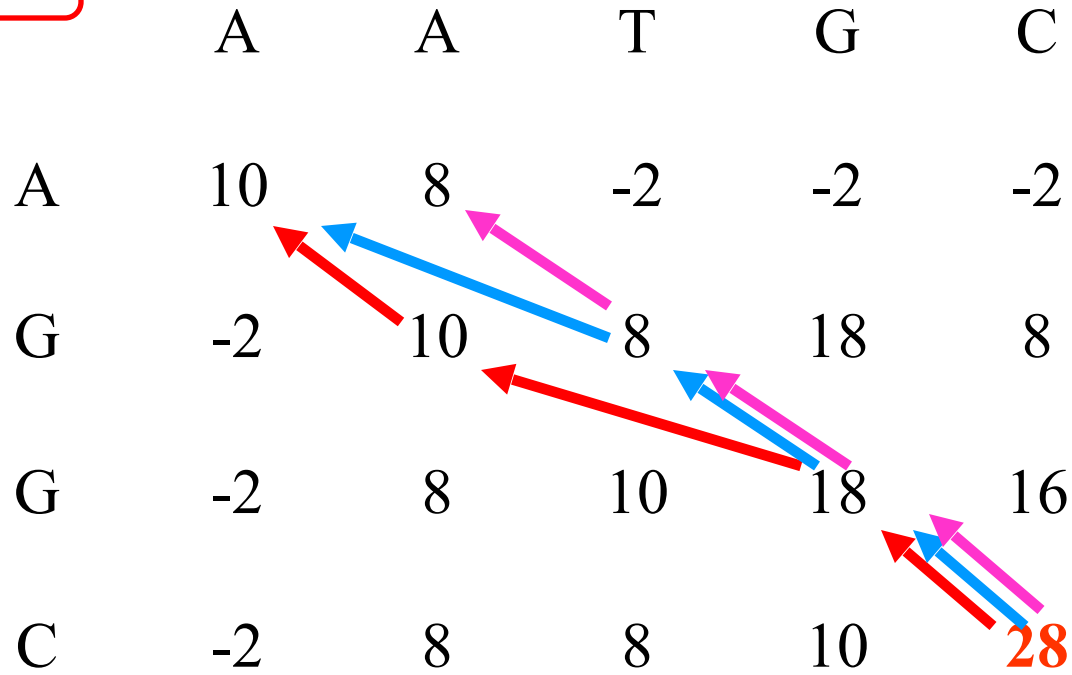

High Score: 28

Alignments:

AATGC
AG GC

AATGC
A GGC

AATGC
AGGC

Statistical Significance of alignment: Shuffling

Hemoglobin α V L S P A D K T N M K A A M G K V C A H A G E Y C A E A L E R M F L S F P T T K T Y F P H F D Gap
Myoglobin G L S E G E W Q L M L N V W G K V E A D I P G H G Q E V L I R L F K G H P E T L E K F D K F K H L K S E D
 L S H C S A Q V K G H G K K V A D A L T N A V A H V D D M P N A L S A L S D L H A H K L R V D P V N K K L
 E M K A S E D L K K H G A T M L T A L G G I L K K K G H E A E I K P L A Q S H A T K H K I P V K Y L E F
 L S H C L L M T L A A H L P A E F T P A V H A S L D K F L A S V S T V L T S K Y R
 I S E C I I Q M L Q S K H P G D F C A D A Q G A M N K A L E L F R K D M A S N Y K E L C F Q G

Score: 355

Shuffling a sequence:

THISISTHECORRECTSEQUENCE



TSTCRTQNHIHOESUCISERCEEE

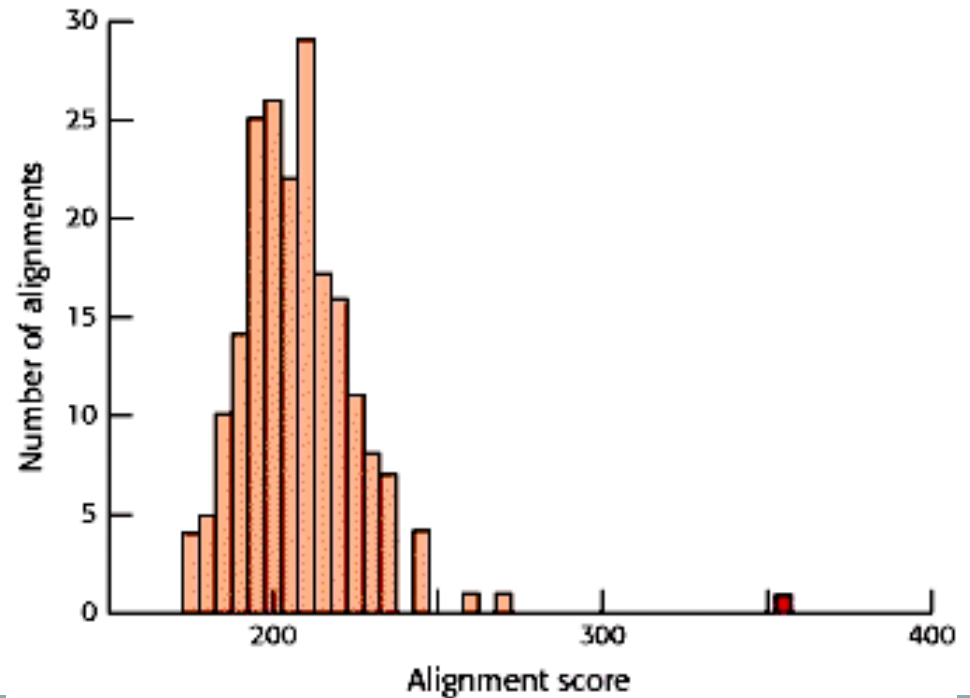

Gap penalty

Most common model:

$$W_N = G_0 + N * G_1$$

W_N : gap penalty for a gap of size N

G_0 : cost of opening a gap

G_1 : cost of extending the gap by one

N : size of the gap

Global versus Local Alignment

Global alignment finds the arrangement that maximizes total score
Best known algorithm: Needleman and Wunsch.

Local alignment identifies highest scoring subsequences,
sometimes at the expense of the overall score.
Best known algorithm: Smith and Waterman.

Local alignment algorithm is just a variation of the global alignment algorithm!

Modifications for local alignment

- 1) The scoring matrix has negative values for mismatches
- 1) The minimum score for any (i,j) in the alignment matrix is 0.
- 1) The best score is found anywhere in the filled alignment matrix

These 3 modifications cause the algorithm to search for matching sub-sequences which are not penalized by other regions (modif. 2), with minimal poor matches (modif 1), which can occur anywhere (modif 3).

Global versus Local Alignment

Match: +1; Mismatch: -2; Gap: -1

	A	C	C	T	G	S
A	1	-3	-3	-3	-3	-3
C	-3	2	1	-2	-2	-2
C	-3	1	3	-1	-1	-1
N	-3	-2	-1	1	0	0
S	-3	-2	-1	0	-1	1

	A	C	C	T	G	S
A	1	0	0	0	0	0
C	0	2	1	0	0	0
C	0	1	3	0	0	0
N	0	0	0	1	0	0
S	0	0	0	0	0	1

Global:
ACCTGS
ACC-NS

ACCTGS
ACCN-S

Local: **ACC**
ACC

Sequence Analysis: Outline

1. Why do we compare sequences?
2. Sequence comparison: from qualitative to quantitative methods
3. Deterministic methods: Dynamic programming
4. Heuristic methods: BLAST
 1. Concept
 2. Ungapped BLAST
 3. Gapped BLAST
5. Multiple Sequence Alignment

Sequence Analysis

1. Why do we compare sequences?
1. Sequence comparison: from qualitative to quantitative methods
1. Deterministic methods: Dynamic programming
1. Heuristics: BLAST
 1. Concept
 2. Ungapped BLAST
 3. Gapped BLAST
1. Multiple Sequence Alignment

BLAST

(Basic Local Alignment Search Tool)

Main ideas:

1. Construct a list of all words in the query sequence
1. Scan database for sequences that contain one or more of the query words
1. Initiate a local alignment for each word match between query and database

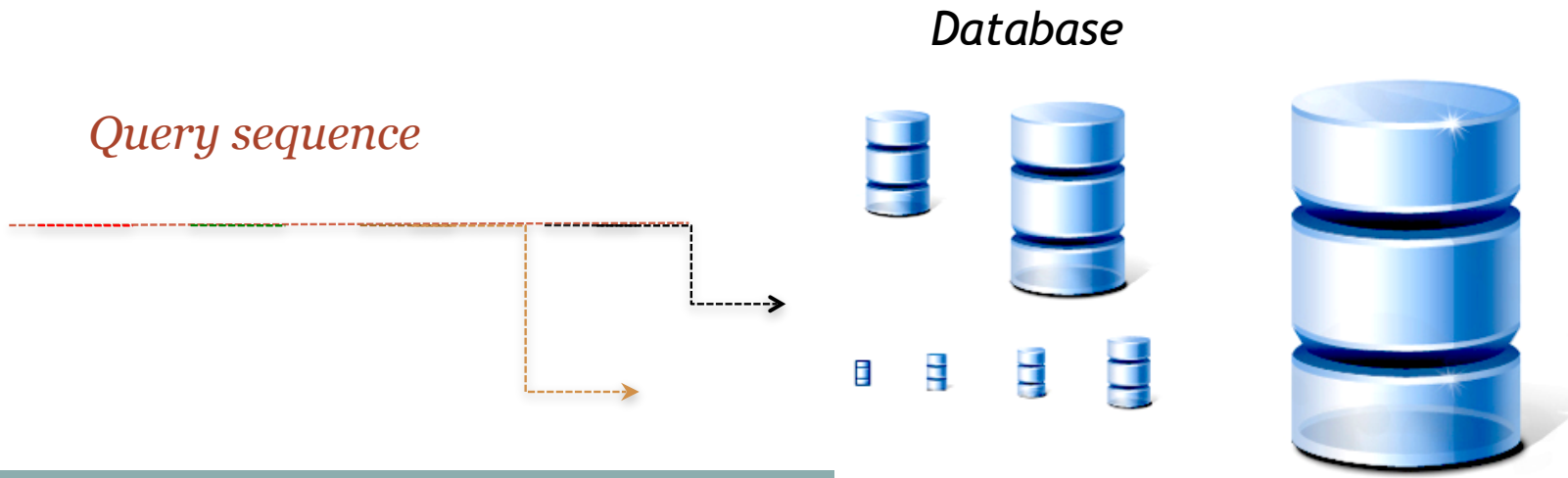

Original BLAST

1. Define dictionary

All words of length k
(typically $k=11$)

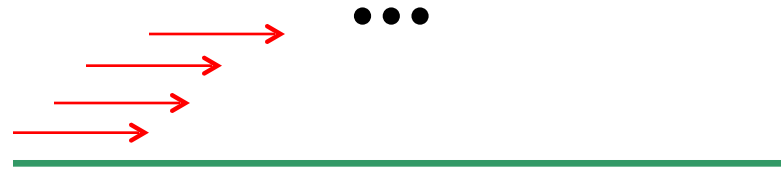

2. Scan database sequences for matches

with alignment score $\geq T$
(typically $T = k$)

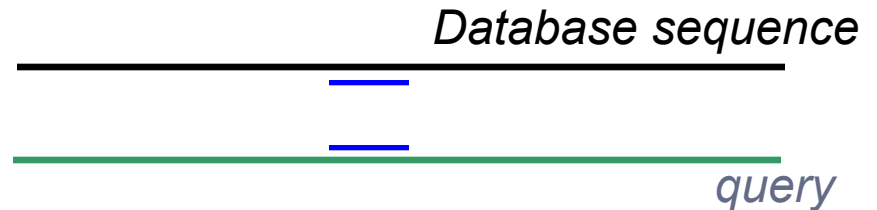

3. Generate alignment

ungapped extensions until score
below statistical threshold

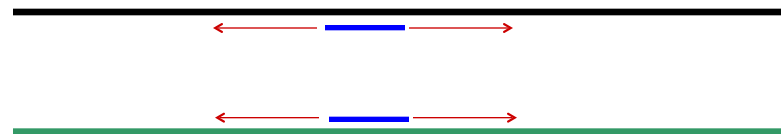

4. Output all local alignments with scores above the statistical threshold

Original BLAST

An example:

$k = 4, T = 4$

- 1) The matching word AGGT initiates an alignment

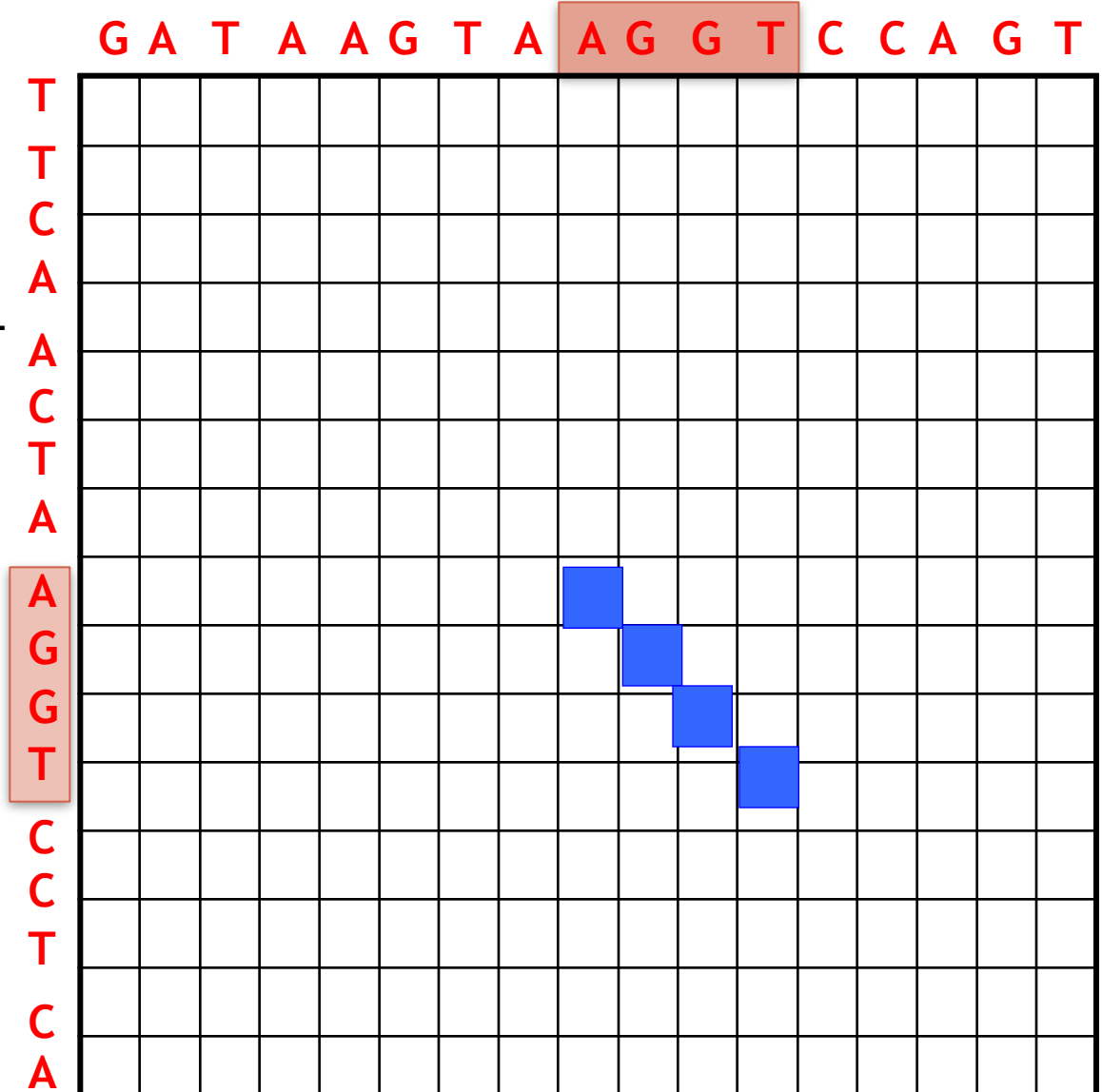

Original BLAST

G A T A A G T A A G G T C C A G T

An example:

$k = 4, T = 4$

- 1) The matching word AGGT initiates an alignment
- 2) Extension of the alignment to the left and right with no gap until alignment score falls below 50%

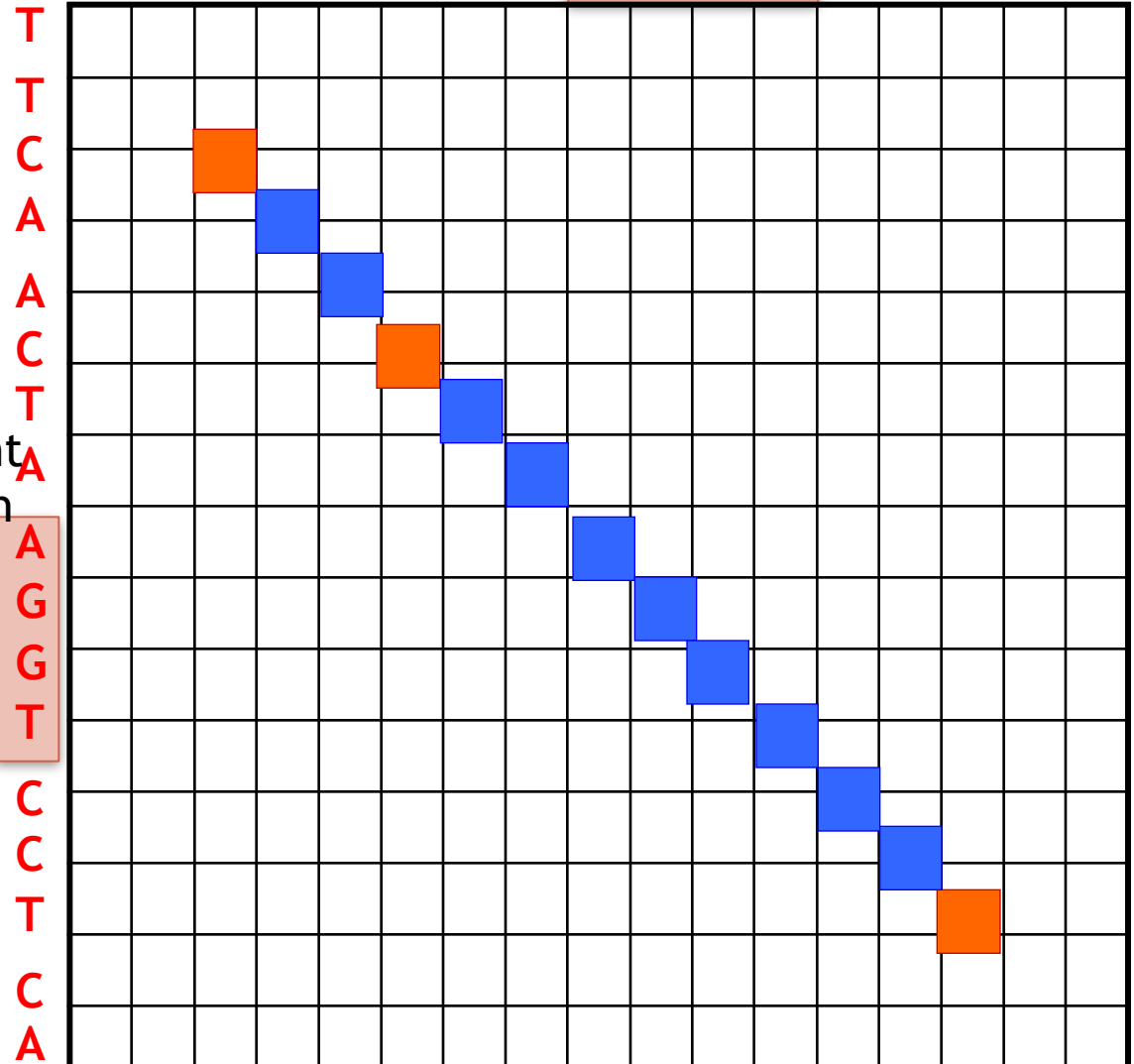

Original BLAST

An example:

$k = 4, T = 4$

- 1) The matching word AGGT initiates an alignment
- 2) Extension of the alignment to the left and right with no gap until alignment score falls below 50%

3) Output:

AAGTAAGGTCC
AACTAAGGTCC

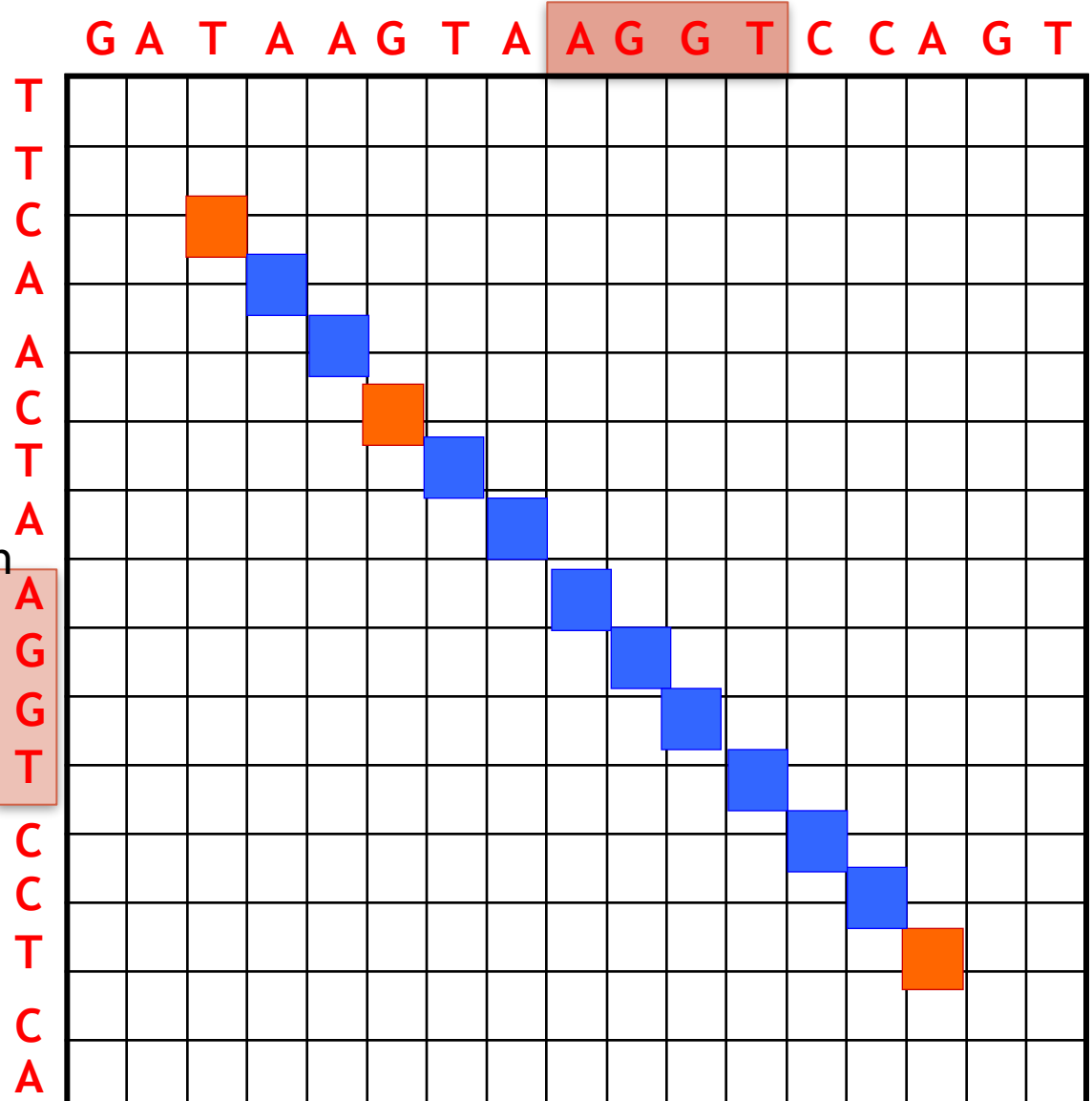

Gapped BLAST

A C G A A G T A A **G G T C** C A G T

An example:

$k = 4, T = 4$

1) The matching word GGTC initiates an alignment

2) Extend alignment in a band around anchor

3) Output:

GTAAGGTCAGT
GTTAGGTC-AGT

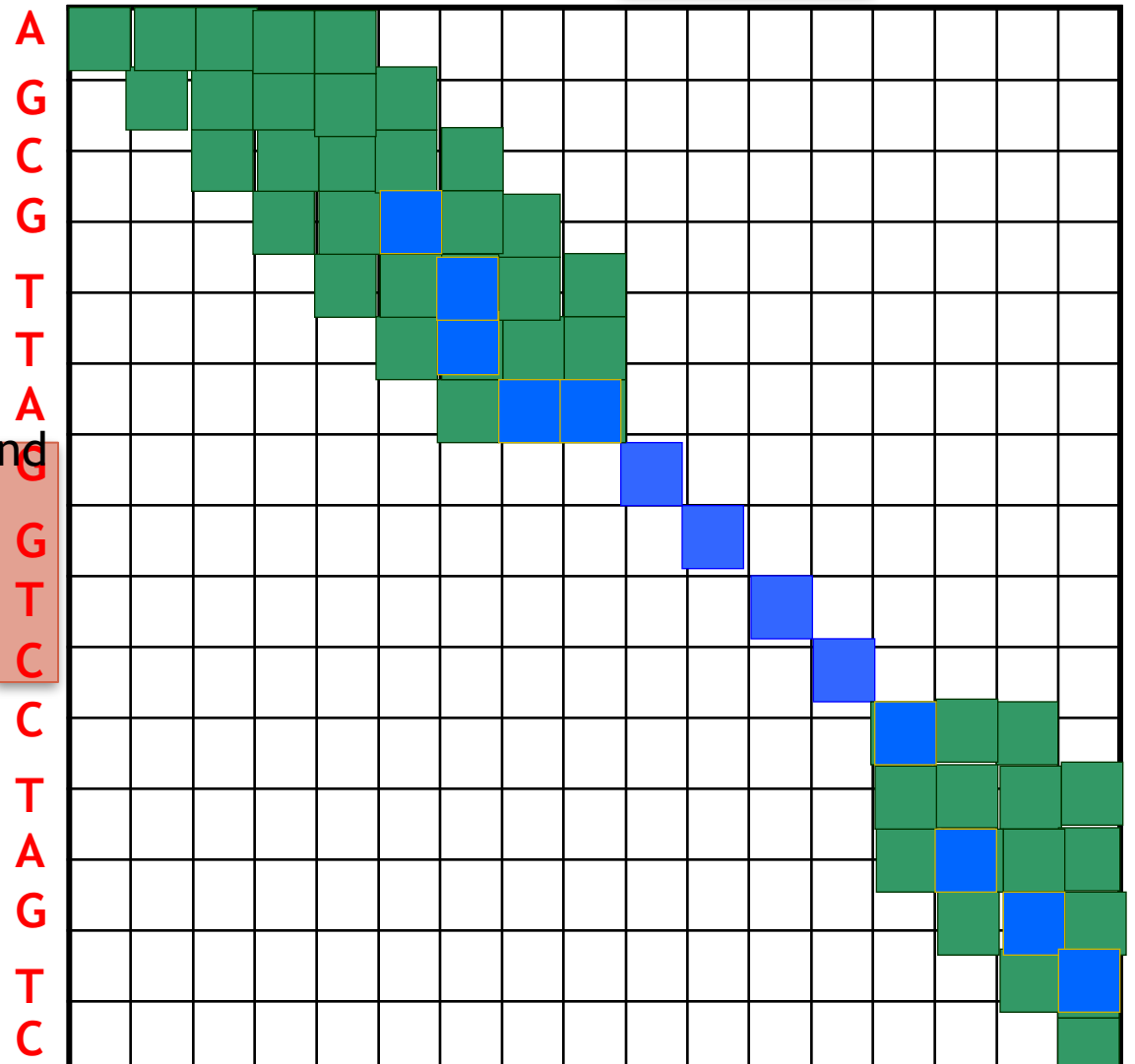

BLAST Portal

 **BLAST** *Basic Local Alignment Search Tool*

[Home](#) [Recent Results](#) [Saved Strategies](#) [Help](#)

▶ [NCBI/ BLAST Home](#)

BLAST finds regions of similarity between biological sequences. [more...](#)

[Learn more](#) about how to use the new BLAST design

BLAST Assembled Genomes

Choose a species genome to search, or [list all genomic BLAST databases](#).

- [Human](#)
- [Mouse](#)
- [Rat](#)
- [Arabidopsis thaliana](#)
- [Oryza sativa](#)
- [Bos taurus](#)
- [Danio rerio](#)
- [Drosophila melanogaster](#)
- [Gallus gallus](#)
- [Pan troglodytes](#)
- [Microbes](#)
- [Apis mellifera](#)

Basic BLAST

Choose a BLAST program to run.

nucleotide blast	Search a nucleotide database using a nucleotide query <i>Algorithms: blastn, megablast, discontinuous megablast</i>
protein blast	Search protein database using a protein query <i>Algorithms: blastp, psi-blast, phi-blast</i>
blastx	Search protein database using a translated nucleotide query
tblastn	Search translated nucleotide database using a protein query
tblastx	Search translated nucleotide database using a translated nucleotide query

BLAST: Input

▶ [NCBI/BLAST/blastp suite](#): BLASTP programs search protein databases using a protein query. [more...](#)

[Reset page](#) [Bookmark](#)

Enter Query Sequence

Enter accession number, gi, or FASTA sequence 

[Clear](#)

```
>1CTF:A|PDBID|CHAIN|SEQUENCE
AAEEKTEFDVILKAAGANKVAVIKAVRGATGLGLKEAKDLVESAPAALKEGVSKDDAEALKKALEE
AGAEVEVK|
```

Query subrange 

From

To

Or, upload file

no file selected 

Job Title

Enter a descriptive title for your BLAST search 

Choose Search Set

Database



Organism
Optional

Enter organism common name, binomial, or tax id. Only 20 top taxa will be shown. 

Entrez Query
Optional

Enter an Entrez query to limit search 

Program Selection

Algorithm

- blastp (protein-protein BLAST)
 PSI-BLAST (Position-Specific Iterated BLAST)
 PHI-BLAST (Pattern Hit Initiated BLAST)

Choose a BLAST algorithm 

Search database **nr** using **Blastp (protein-protein BLAST)**

Show results in a new window

▶ [Algorithm parameters](#)

BLAST Parameters

Algorithm parameters

General Parameters

Max target sequences

100

Select the maximum number of aligned sequences to display

Short queries

Automatically adjust parameters for short input sequences

Expect threshold

10

Word size

3

Scoring Parameters

Matrix

BLOSUM62

Gap Costs

Existence: 11 Extension: 1

Compositional adjustments

Composition-based statistics

Filters and Masking

Filter

Low complexity regions

Mask

Mask for lookup table only

Mask lower case letters

Statistics of Protein Sequence Alignment

- *Statistics of global alignment:*

Unfortunately, not much is known! Statistics based on Monte Carlo simulations (shuffle one sequence and recompute alignment to get a distribution of scores)

- *Statistics of local alignment*

Well understood for ungapped alignment. Same theory probably apply to gapped-alignment

Statistics of Protein Sequence Alignment

What is a local alignment ?

“Pair of equal length segments, one from each sequence, whose scores can not be improved by extension or trimming. These are called high-scoring pairs, or HSP”

<http://www.people.virginia.edu/~wrp/cshl98/Altschul/Altschul-1.html>

The E-value for a sequence alignment

HSP scores follow an extreme value distribution, characterized by two parameters, K and λ .

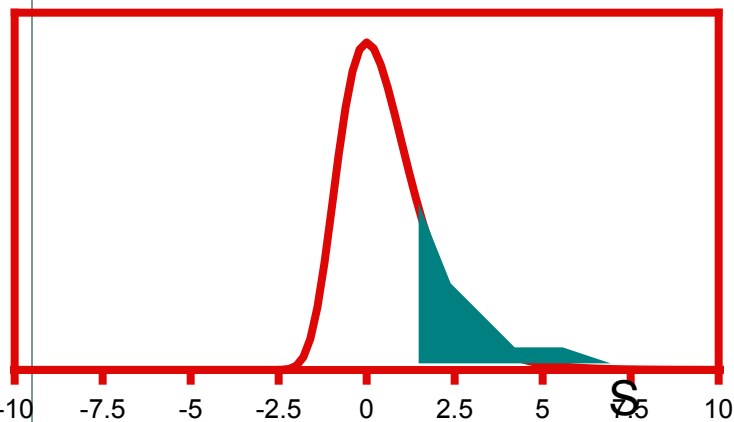

The expected number of HSP with score at least S is given by:

$$E = Kmn \exp(-\lambda S)$$

m, n : sequence lengths
 E : E-value

The Bit Score of a sequence alignment

Raw scores have little meaning without knowledge of the scoring scheme used for the alignment, or equivalently of the parameters K and λ .

Scores can be normalized according to:

$$S' = \frac{\lambda S - \ln(K)}{\ln(2)}$$

S' is the **bit score** of the alignment.

The E-value can be expressed as:

$$E = mn2^{-S'}$$

The P-value of a sequence alignment

The number of random HSP with score greater or equal to S follows a Poisson distribution:

$$P(X \text{ random HSP with score} \geq S) = \exp(-E) \frac{E^X}{X!}$$

(E : E-value)

Then:

$$P(0 \text{ random HSP with score} \geq S) = \exp(-E)$$

$$P_{val} = P(\text{at least 1 random HSP with score} \geq S) = 1 - \exp(-E)$$

Note: when $E \ll 1$, $P \approx E$

The database E-value for a sequence alignment

Database search, where database contains N_S sequences corresponding to N_R residues:

1) All sequences are a priori equally likely to be related to the query:

$$E_{DB} = N_S K m n \exp(-\lambda S)$$

2) Longer sequences are more likely to be related to the query:

$$E_{DB2} = K m N_R \exp(-\lambda S)$$

BLAST reports E_{DB2}

Sequence Analysis: Outline

1. Why do we compare sequences?
2. Sequence comparison: from qualitative to quantitative methods
3. Deterministic methods: Dynamic programming
4. Heuristic methods: BLAST
5. Multiple Sequence Alignment
 1. Concept
 2. Dynamic programming
 3. Heuristics

Why multiple sequence alignment?

Seq1 : AALG**C**LVKDYFPEP--VTVS**W**NSG---

Seq2 : VSLT**C**LVKGFYPSD--IAVE**W****W**SNG--

Why multiple sequence alignment?

Seq1 : AALG**C**LVKDYFPEP--VTVS**W**NSG---

Seq2 : VSLT**C**LVKGFYPSD--IAVE**W**WSNG--

Seq3 : VTIS**C**TGSSSNIGAG-NHVK**W**YQ**QLPG**

Seq4 : VTIS**C**TGTSSNIGS--ITVN**W**YQ**QLPG**

Seq5 : LRLS**C**SSSSGFIFSS--YAMY**W**VR**QAPG**

Seq6 : LSLT**C**TVSGTSEFDD--YYST**W**VR**QPPG**

Seq7 : PEVT**C**VVVDVSHEDPQVKFN**W**YVDG--

Seq8 : ATLV**C**LISDFYPGA--VTV**W**KADS--

MSA: Dynamic programming?

Theoretically, it is possible to extend the dynamic programming technique to N sequences.

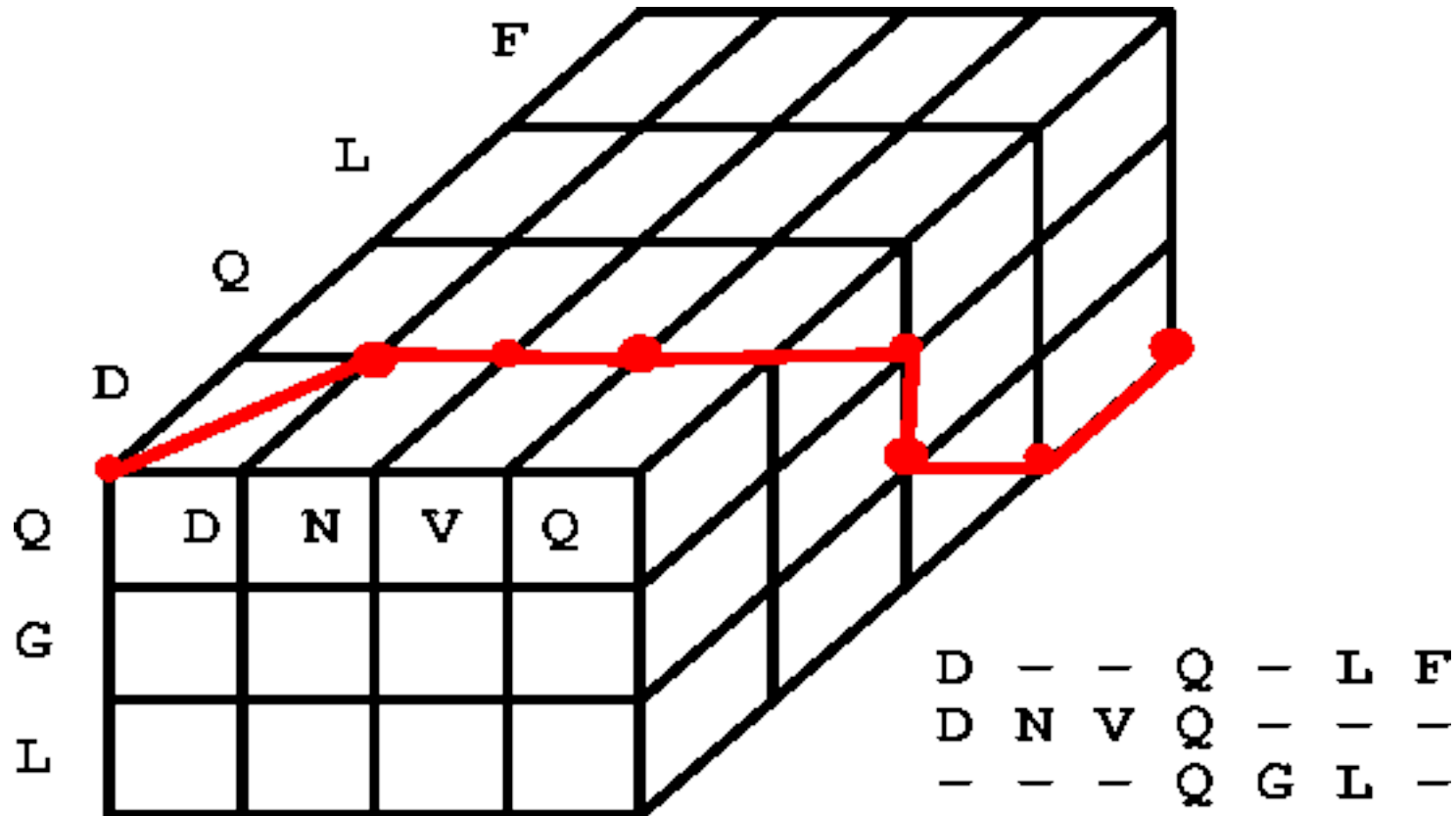

MSA: Dynamic programming?

- One of the most important properties of an algorithm is how its execution time increases as the problem is made larger. This is **the computational complexity** of the algorithm

- There is a notation to describe the algorithmic complexity, called **the big-O notation**.

If we have a problem of size (i.e. number of input data points) n , then an algorithm takes **$O(n)$** time if the time increases linearly with n .

-It is important to realize that an algorithm that is **quick on small problems may be totally useless on large problems** if it has a bad $O()$ behavior.

MSA: Dynamic programming?

Standard description of algorithms, where n is the size of the problem, and c is a constant:

Complexity	Type	Computing time for $n=1000$ (1 operation=1s)
$O(c)$	Dream...	Seconds
$O(\log(n))$	Really good	10 seconds
$O(n)$	good	1000 seconds = 5 mins
$O(n^2)$	Not so good	10^6 seconds = 11.5 days
$O(n^3)$	Bad	10^9 seconds = 31 years
$O(c^n)$	Catastrophic!	Millions of years!!

MSA: Dynamic programming?

Computational complexity of dynamic programming:

- Two sequences of length M : $O(M^2)$
- Three sequences of length M: $O(M^3)$
- N sequences of length M: $O(M^N)$

-> dynamic programming is not a reasonable option for aligning multiple sequences!

MSA: Approximate methods

1. Progressive global alignment

Start with the most similar sequences and builds the alignment by adding the rest of the sequences

2. Iterative methods

Start by making alignments of small group of sequences and then revise the alignment for better results

3. Alignment based on small conserved domains

4. Alignment based on statistical or probabilistic models of the sequence

Multiple sequence alignment: using conserved domains

Sequences often contain highly conserved regions

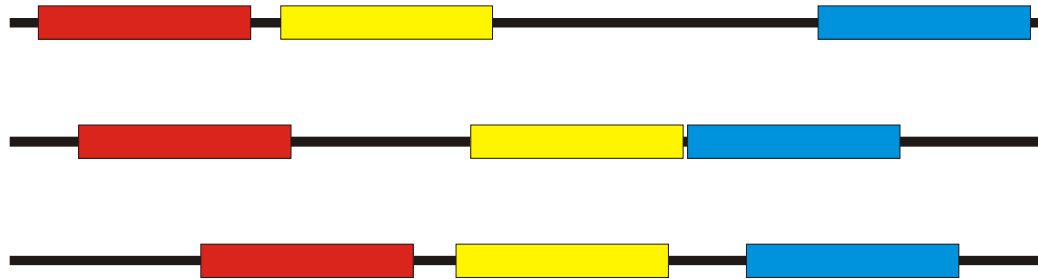

These regions can be used for an initial alignment

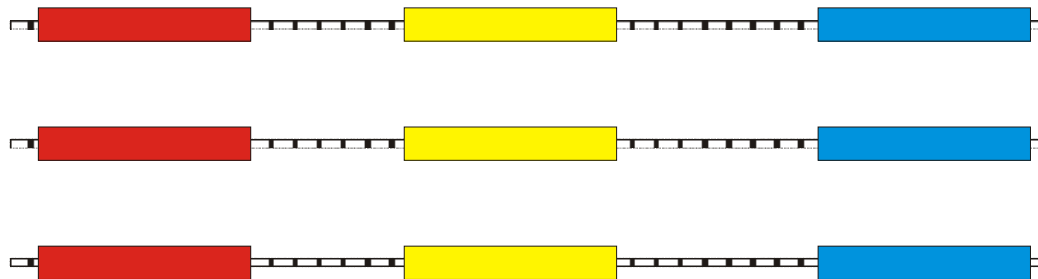

How to generate a multiple sequence alignment?

	Raw	Alignment
Human	N Y L S	
Chimp	N K Y L S	
Gorilla	N F S	
Orangutan	N F L S	

How to generate a multiple sequence alignment?

Sequence elements are not truly independent but related by phylogeny:

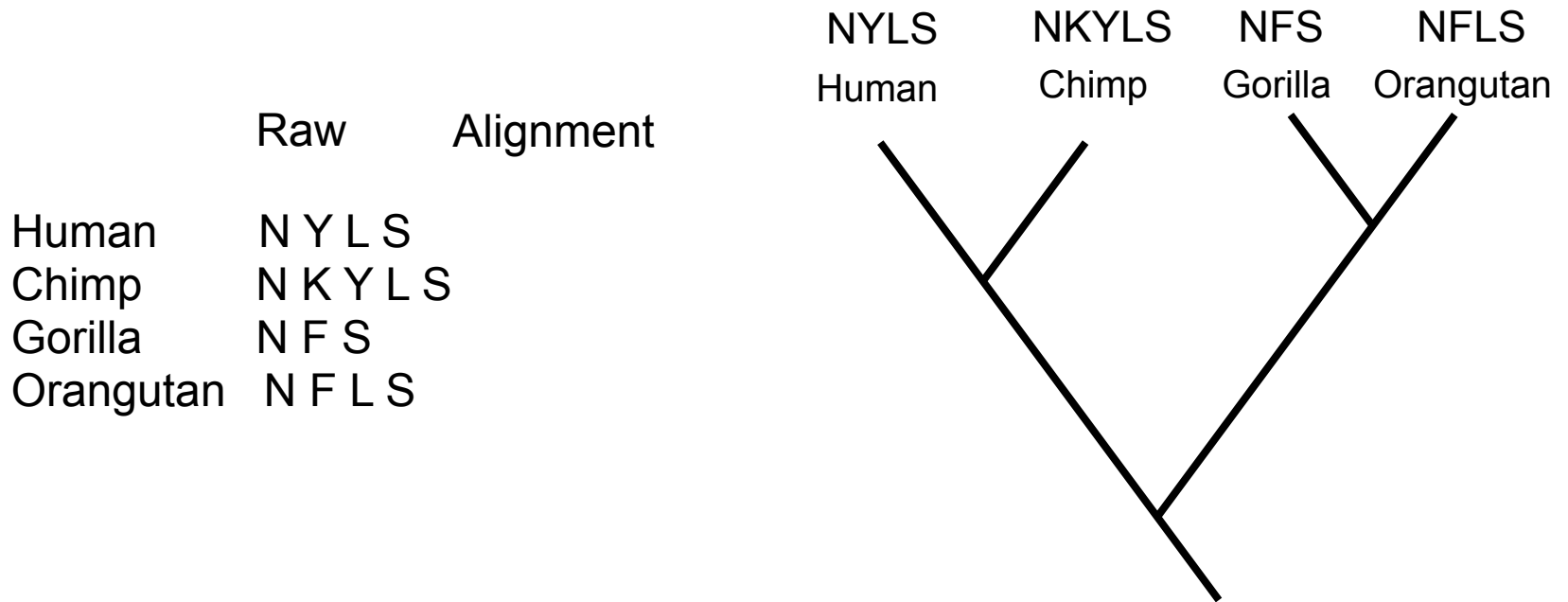

How to generate a multiple sequence alignment?

Sequence elements are not truly independent but related by phylogeny:

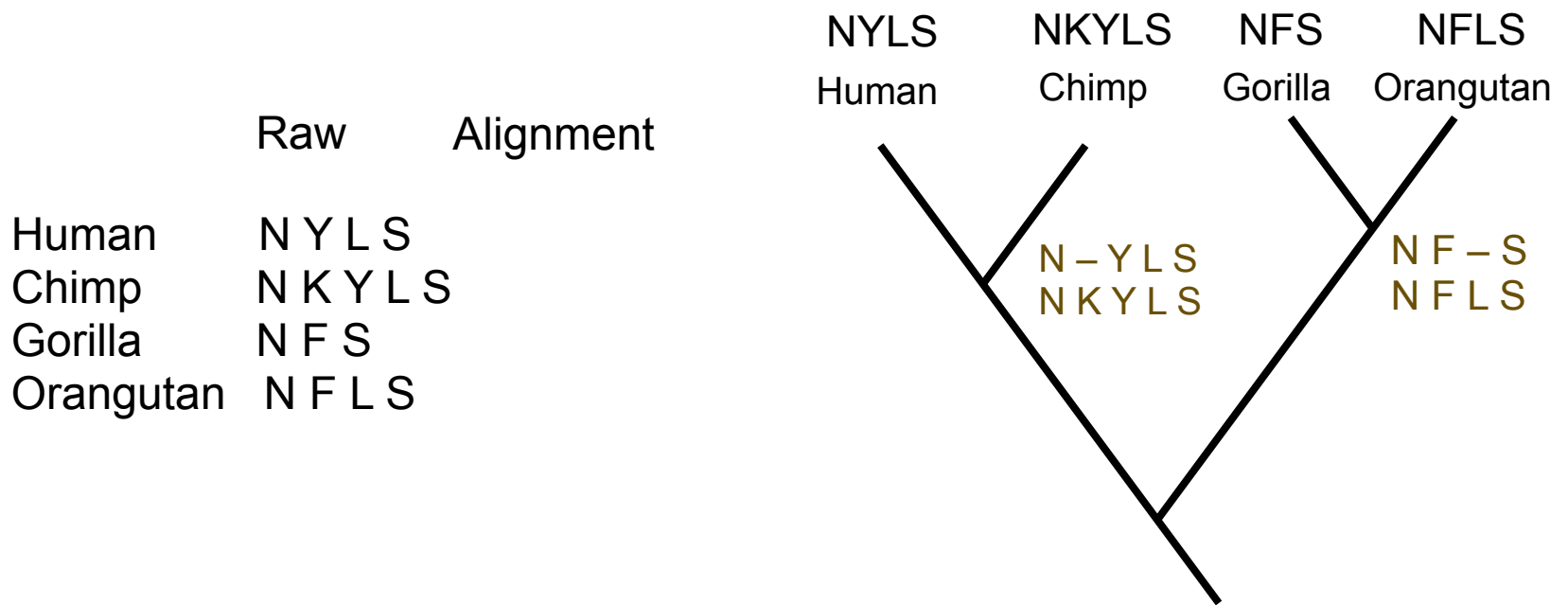

How to generate a multiple sequence alignment?

Sequence elements are not truly independent but related by phylogeny:

	Raw	Alignment
Human	N Y L S	N - Y L S
Chimp	N K Y L S	N K Y L S
Gorilla	N F S	N - F - S
Orangutan	N F L S	N - F L S

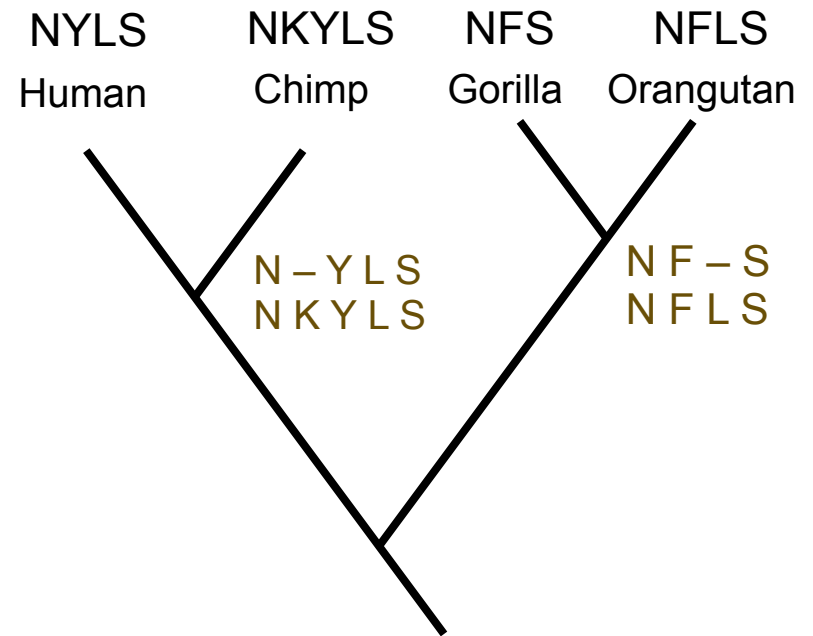

Multiple sequence alignment: Progressive method

A) Perform pairwise alignments

	HAHU	HBHU	HAHO	HBHO	MYWHP	P1LHB	LGHB
HAHU							
HBHU	21.1						
HAHO	32.9	19.7					
HBHO	20.7	39.0	20.4				
MYWHP	11.0	9.8	10.3	9.7			
P1LHB	9.3	8.6	9.6	8.4	7.0		
LGHB	7.1	7.3	7.5	7.4	7.3	4.3	

Multiple sequence alignment: Progressive method

A) Perform pairwise alignments

	HAHU	HBHU	HAHO	HBHO	MYWHP	P1LHB	LGHB
HAHU							
HBHU	21.1						
HAHO	32.9	19.7					
HBHO	20.7	39.0	20.4				
MYWHP	11.0	9.8	10.3	9.7			
P1LHB	9.3	8.6	9.6	8.4	7.0		
LGHB	7.1	7.3	7.5	7.4	7.3	4.3	

B) Cluster based on similarity

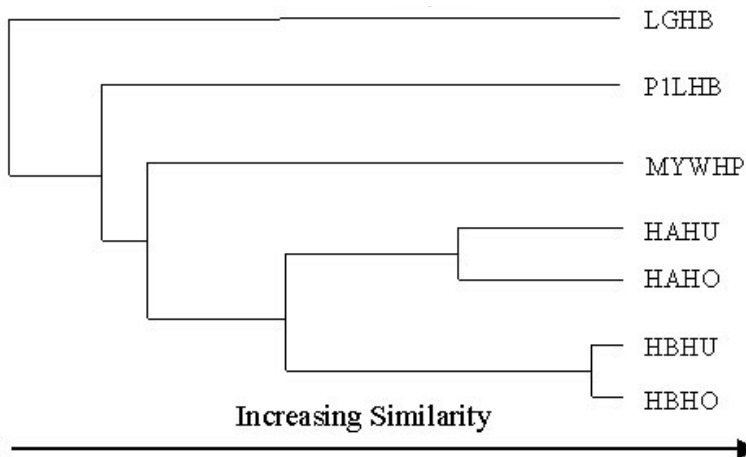

Multiple sequence alignment: Progressive method

A) Perform pairwise alignments

	HAHU	HBHU	HAHO	HBHO	MYWHP	P1LHB	LGHB
HAHU							
HBHU	21.1						
HAHO	32.9	19.7					
HBHO	20.7	39.0	20.4				
MYWHP	11.0	9.8	10.3	9.7			
P1LHB	9.3	8.6	9.6	8.4	7.0		
LGHB	7.1	7.3	7.5	7.4	7.3	4.3	

B) Cluster based on similarity

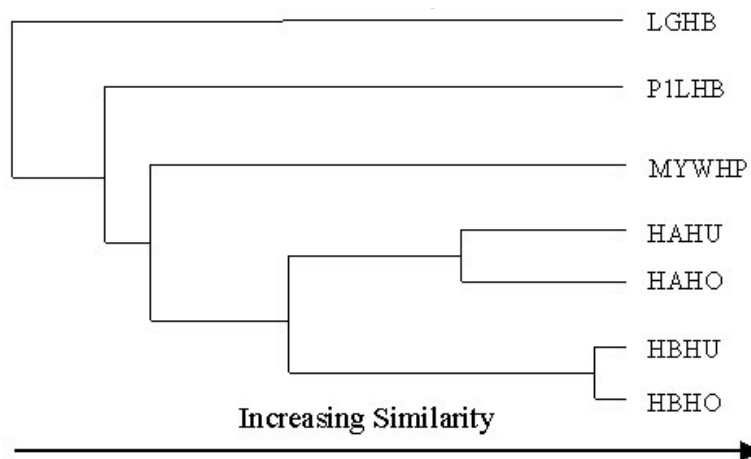

C) Generate Multiple Sequence Alignment

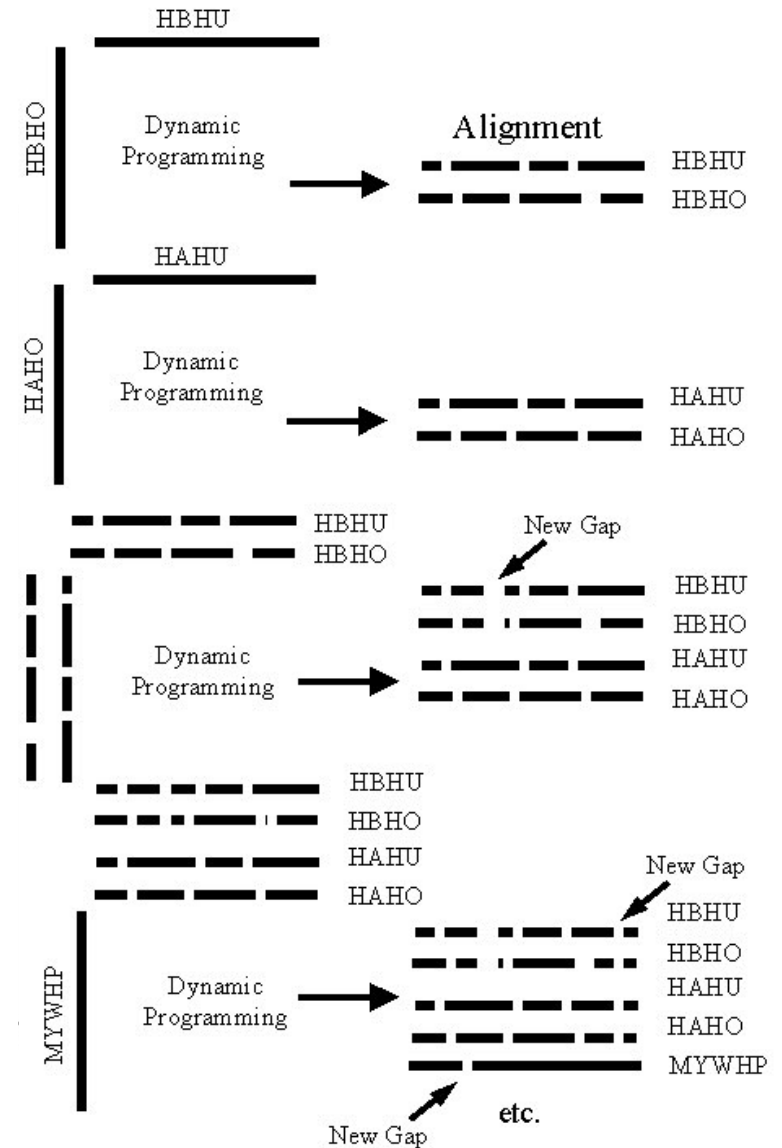

Some References on Alignments

Global Alignment:

Needleman, S.B. and Wunsch, C.D. (1970). "A general method applicable to the search for similarities in the amino acid sequence of two proteins". *Journal of Molecular Biology* **48 (3): 443–53**

Local alignment:

Smith, T.F. and Waterman, M.S. (1981) "Identification of Common Molecular Subsequences". *Journal of Molecular Biology* **147: 195–197**

ClustalW:

Thompson, J. D., Higgins, D.G. and Gibson, T.J. (1994) "CLUSTAL W: improving the sensitivity of progressive multiple sequence alignment through sequence weighting, positions-specific gap penalties and weight matrix choice". *Nucleic Acids Research*, **22:4673-4680**

What have we learnt?

1) **Sequence analysis** is one of the keys that will help us unravel the information coming from Genomics

2) Vocabulary

Analogy: The similarity of characteristics between two species that are not closely related

Homology: Similarity in characteristics resulting from shared ancestry

- **Paralog:** Homologous sequences are paralogous if they were separated by a gene duplication event
- **Ortholog:** Homologous sequences are orthologous if they were separated by a speciation event

3) In bioinformatics we often assume that **sequence similarity implies homology**. However we do need to be cautious.

What have we learnt?

- 4) Sequence analysis starts with **an analysis of its content**
 - 1) **DNAs:**

Chargaff rule2: the composition of DNA varies from one species to another
 - 2) **Proteins:**

Tri-peptide content identifies the kingdom of life (bacteria, archea or eukaryot)
- 5) **DotPlots** are very useful, qualitative tools for sequence comparison
- 4) **Scoring** between sequences is usually based on **substitution matrices**
Most common matrices: **PAM** and **BLOSUM**

What have we learnt?

1. **Dynamic programming (DP)** is an algorithm for aligning two sequences that is guaranteed to generate the **optimal alignment**, under the hypothesis that the **scores are additive**.
2. There are two variants of DP used for sequence analysis
Global alignment: Needleman and Wunsch
Local alignment: Smith and Waterman
3. DP is too slow for comparing a sequence with a large database
4. **BLAST** provides a heuristic method for detecting sequences that are similar
5. **BLAST is best for detection** and should not be trusted for the alignment itself

What have we learnt?

6) Multiple sequence alignment: definition

A multiple sequence alignment is an alignment of $n > 2$ sequences obtained by inserting gaps (“-”) into sequences such that the resulting sequences have all length L . MSW can help to reveal biological facts about proteins, to establish homology,...

7) Difficulties in generating MSA

Most pairwise alignment algorithms are too complex to be used for N-wise alignments

8) Three main types of MSA algorithms:

- Progressive global alignment (starts with the most alike sequences)
 - * e.g., ClustalW, ClustalX
- Iterative methods (initial alignment of groups of sequences that are revised)
 - * MultAlin, PRRP, SAGA
- Alignments based on locally conserved patterns